

KBW **BannerFlex**[®] *by Consort*

BANNER HARDWARE GUIDEBOOK

The **best** possible choice for exterior light pole banner hardware.



Table of Contents

| | |
|--|-----------|
| Introduction | 3 |
| Purpose of Banner Hardware Guidebook | 3 |
| Description of Consort Display Group | 3 |
| KBW Kalamazoo Banner Works | 4 |
| History | 4 |
| Uncontested Leader in Industry and Why | 4 |
| Introduction of our Innovations | 4 |
| Banner Issues with Communities and Power Companies | 5 |
| Banners vs Wind | 5 |
| Wind Loads | 5 |
| Wind Tunnel Testing | 6 |
| The Detrimental Effects of Wind Slits in Banners | 7 |
| Choosing the Right Hardware | 7 |
| The Basics | 7 |
| The BannerFlex System | 7 |
| The New Airow® Eccentric Arm | 7 |
| Banding and Bolting Recommendations | 8 |
| Wood Telephone and Utility Poles - Special Information | 8 |
| KBW BannerFlex Hardware Guideline Chart | 9 |
| Products and Product Specifications | 10 |
| Banner Hardware | 10 |
| KBW BannerFlex® D3 | 11 |
| KBW BannerFlex® Airow® | 10 |
| KBW BannerFlex® Metro® | 12 |
| KBW BannerFlex® JR | 13 |
| Other Types of Brackets, in General | 14 |
| Fasteners | 15 |
| Hardware Accessories | 15 |
| The Tie-Down Mount | 15 |
| Adaptors | 15 |
| Wall Mounting Brackets | 16 |
| Finials | 17 |
| Flag Pole Adaptors | 17 |
| Flower Pot Adaptors | 17 |
| How to Order | 18 |
| Installation Instructions | 20 |
| First 10-Year Banner Bracket Warranty | 27 |
| Disclaimer / Customer Responsibility | 27 |

Purpose of Banner Hardware Guidebook

Preface: This information is presented especially for those considering the specification of banner brackets for use with vertical street banners, which are typically installed in communities for exterior light and utility poles. This information is recommended for anyone considering the purchase of competing products to the KBW Kalamazoo Banner Works product line. We have invested considerable time and money in the testing of our banners and brackets, including four separate wind tunnel tests. This compilation of information is a result of that knowledge base and is intended to be a narrative for customers, engineers, utility companies and public works officials to briefly explain our products, our testing and what, in general, we know from experience about vertical banners on light poles.



As always if you need additional information visit our website or contact your Consort KBW representative by phone or email. **Our sales representatives are available to answer any additional questions or concerns.**

Please Note: The installation of banners on exterior light and utility poles is serious business. The attachment of any devices above the heads of the public and above vehicles demands precision products tested and accurately manufactured and installed correctly. KBW Kalamazoo Banner Works by Consort Display Group has been innovating, testing and manufacturing these specific products since 1983.

A Little About Us...

Consort Display Group began in 1983 as Kalamazoo Banner Works™ with architect Roger Lepley, AIA, and his innovative concepts for outdoor banners and hardware. Almost three decades later, KBW continues to set the standards with the most trusted name in hardware and leads an incredible collection of display solutions that are manufactured in Kalamazoo, Michigan.

Consort Display Group is the proud manufacturer of Kalamazoo Banner Works™, KBW BannerFlex® Hardware, Display One® Exhibit System, Dori Pole® Pennant System, Podia® Tabletop Display, Abstracta® Modular Display System, Mya® Personal Tables and Abstracta3® Furniture.



Visit www.consort.com or contact our sales team for all your display solutions and visit our blog at www.bannersanddisplay.blogspot.com for up to the minute info on Consort banners and displays.



www.consort.com



How and why has KBW by Consort been the uncontested leader in exterior light pole banner bracket innovation?

Kalamazoo Banner Works was **the first banner company in the world to actually design light pole brackets specifically with performance in mind.** Prior to this, brackets consisted of steel pipe arms welded to steel collars and then bolted to light and utility poles. The failings of this primitive method were the metal would bend and stay bent in the wind. The collars were rarely tight enough on the varying-sized poles and subsequently easily loosened in wind storms. This resulted in shoddy installations and allowed the banners to flop around and rip and tear relentlessly in wind gusts making unattractive and potentially dangerous applications. In addition the steel rusted quickly and added one more eyesore to the installation.

The Introduction of Fiberglass Banner Arms

KBW's first innovation was the use of fiberglass arms in 1983, the same year that Kalamazoo Banner Works began its business. Now, when you see a banner bracket on a light pole and you notice the round, white fiberglass rod holding the banner, take note **KBW was the first in the world to come up with the concept to use fiberglass.** Next, we dismissed steel collars in favor of a system of stainless steel banding that takes the exact shape of each light pole's exact cross-section.

The Introduction of the Universal Pole Casting Mounted with Stainless Steel Banding

KBW initiated the versatile method of using stainless steel banding to attach brackets to light poles. This started with heavy duty Band-It® brand, tool-applied banding and now includes custom-made heavy duty screw gear banding for certain installations. Stainless steel is not only more corrosion and heat resistant than other metals, it is also durable, recyclable and flexible.

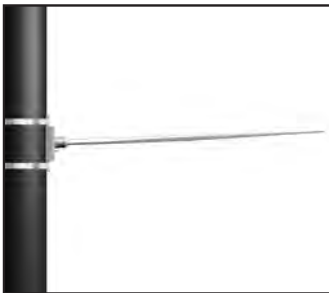

The Introduction of the "Canted" Fiberglass Banner Arm

When you are told that a bracket arm is "canted" say, 2° or 4°, to stretch the banner and keep it trim and taut, think of **KBW as the originator of this concept in 1984.** This cant avoids banner flapping and allows the wind force to immediately be transferred to the fiberglass which then deflects some of the force, depending on the KBW bracket model and the size of the banner. Not only does this slight angular deviation make for a clean and crisp presentation, this extends the life of banners and increases the security of the installation of the hardware.

The Introduction of the First Adjustable Banner Bracket

KBW first developed and patented the BannerFlex® D3 "adjustable" bracket in 1988 to allow ease of installation and banner changes and to ensure the taut installation of varying size banners. A major innovation for the industry, this technology continues to dominate the market.



The “Banner Issue” with Communities and Power Companies

Municipalities and power companies often are in discussion over the use of vertical banners for city installations on light poles. Questions often asked include the following: What type of banner hardware is best? How strong do the poles need to be? What size should the banners be? And, who should be allowed to use the poles and banner brackets?

Banners have become more popular worldwide for cities and municipalities, colleges and universities, shopping centers, and neighborhood districts among others. Used to promote community pride as well as specific happenings such as sporting and festival events, **banners are an effective medium to communicate special messages, generate excitement, promote businesses, and welcome visitors.**



In many cities, the power companies own the utility poles on which the city has placed or wishes to place banners. In our experience, the majority of power companies involved have been either readily willing to be part of the communities' promotion-through-banner efforts or have reluctantly, but successfully, worked with the cities to make the banner programs possible. In other cases the power companies have been uncooperative and/or unwilling to get involved.

As a leading outdoor banner products innovator and manufacturer we, of course, would like to see the two entities work together for the good and vitality of the community. This certainly includes the safety of the community as a whole. For this reason, **KBW has compiled data to assist power companies and communities to select the proper poles, brackets, banners and banner sizes that would be appropriate for long-term banner display.**

Banner Wind Loads

It's not hard to understand the concern that the utilities have with banners. Wind load pressures are considerably different on poles that have, essentially, “sails” mounted to them than on poles without banners. Of course, some traffic signs mounted on poles catch wind as well but the signs are usually not as big and are generally not mounted as high above the ground as banners. Pole integrity is the immediate topic of concern. The strength of poles is affected by potentially undersized cross-sections, age and integrity of base connections and pole materials. As a banner hardware manufacturer we advise the installing entity to obtain the full cooperation and consent from the local utility or pole owner prior to the installation of banners on light poles. Our instructions suggest that poles be inspected and approved for the extra wind loads. In most cases this appears to be a matter easily handled. And, we have technical wind load data, as noted below, that we supply upon request.

Because power companies require banner wind load information in order to help determine pole suitability, we have conducted wind load tests in actual wind tunnels as well as wind load or aeronautic computer simulations of banner installations. We have also done lab testing and computer diagnostic testing on our banner hardware components. This information not only allows us to warrant and improve our products but also is the kind of information on which power companies or pole owners can base their determination of individual pole suitability. **The data that we have is proprietary to our BannerFlex brand brackets and should not be used as indicative of strength and/or performance of any other hardware produced by other manufacturers.**



The First Full-Size Wind Tunnel Tests on Street Pole Banners and Hardware

To ensure adequate strength and durability, KBW contracted to undergo the first full-size wind tunnel tests in 1984 at the GM Aeronautical Laboratory in Detroit. Subsequently, KBW has performed 4 other tunnel tests. Three smaller tests were performed at the University of Michigan tunnels in 2001 and the fourth was a comprehensive full-size test at the Jacob-Sverdrup facility in Allen Park, Michigan in 2002.

The wind force and wind reduction information included with this report and included in our online **Wind Force Calculator Program** are a result of those tests along with data gathered from our strength testing conducted at the Consort manufacturing facility and computer modeling carried out by our structural engineering consultants, Nehil-Sivak, PC of Kalamazoo, Michigan.

The data that seems to be requested most often is the **“EPA”** for various size banner installations at various wind velocities. EPA or Effective Projected Area is a value given to outdoor pole-mounted equipment, such as lighting fixtures, signs and banners, based on the sum of the pole and attached fixture(s) surface area and shape, in square feet. For banners mounted with flexible arm brackets the EPA will change (get smaller) with increasing wind loads. A good way to envision the EPA of wind-loaded banners is as the deflected shape of the banner projected onto a flat surface. That is, the less shadow the resulting banner would project, the less the EPA.

Below is an example of some of that type of data utilizing our new BannerFlex Airow, an eccentrically milled pultruded fiberglass arm. This and our original D3 models are shown on the online Wind Force Calculator. The calculations given below are for single banner

installations or one banner per utility pole. For double banner installations you would double the EPA numbers. Using our new Airow Arm with a 70 mph “head-on” wind, one 30” x 94” banner (area = 19.575 sq ft before the wind blows) has an EPA of 11.90 sq ft, which means that about 32% of the wind is spilled due to fiberglass arm deflection. At 90 mph the EPA is 10.4 sq ft and the wind reduction is about 46.9% and at 100 mph the EPA is 9.5 sq ft and the wind reduction is 51.49%. Other wind load information, such as pounds per square foot exerted at various velocities, is available on the Wind Force Calculator and by contacting your Consort KBW sales representative.



Based on practical use and it being our most popular size for banners the installations that we tested in the tunnels were all double 30” x 94” banners. This also represents the largest of our stock sizes and therefore the highest winds loads with which we typically deal. Smaller banners and installations of only one banner per pole will decrease loads significantly. If banners are desired on utility poles that will not handle the larger banners, even with the benefits of the new Airow configuration, we encourage the customer to consider the 30”x 60” size in single or double installations. The BannerFlex system deflects less with this smaller size because of the significantly lower wind loads but the action of the fiberglass arm moving with the banner promotes longer banner life due to decreased stress on the fabric and the hems.

The Acknowledgement that Winds Slits in Banners are Actually Detrimental

We are often asked for recommendations on the topic of wind holes or slits in banners meant to allow wind to pass through banners, hopefully to reduce total banner wind load. In both of our full-size wind tunnel tests, in 1984 and 2002, we tested banners with wind slits on our BannerFlex hardware as well as non-vented banners. In both cases, it was visually obvious wind holes became, in fact, detrimental to the banners due to vibration and fabric stress within the banner and they tended to increase the wind load rather than reduce it.



How can they increase load? The holes allowed the fabric to ripple and catch more wind increasing the drag factor. The fiberglass arms deflected more rather than less indicating more force on the system with the holes than without. Also, the banners vibrated considerably more at 60 mph to 100 mph with the slits than without.

The typical slit pattern, requested by unknowing customers to cut into the banners and seen on many non-KBW banners, do not allow enough wind relief to make a difference regardless of the rippling effect. For example, three (3) 6" diameter "half-moons" cut into a 30" x 94" banner represent 1.5% of the surface area. Twice that number of holes, more than normally seen, is only 3% of the surface area. Therefore, with our BannerFlex fiberglass arm system, **we do not recommend wind holes or slits to our customers.** For maximum wind reduction, specify the KBW BannerFlex Airow banner bracket.

Choosing the Right Hardware – The Basics of BannerFlex

What is the best design for light pole banner brackets? Since 1983 KBW has spent considerable resources being the innovator in this field. Through our testing we developed the original BannerFlex bracket in 1984, in response to our own concerns for banner longevity and to reduce stresses on light poles. **This marked the first vertical street banner bracket to incorporate the use of fiberglass arms.** In 1988 we improved the original bracket with the BannerFlex II which had a patented feature allowing arms to be removed from the Main Casting if no banner is displayed and the Main Casting remains on the pole until it is again needed. KBW manufactures adaptors for flag poles and flower pot holders that can be used as needed and replaced with the optional flag holder adaptors and flower pot holder adaptors. Known also as the KBW BannerFlex D3, the patented BannerFlex III was introduced in 1997 and features corrosion-resistant aluminum and set-screws and a lighter, yet stronger profile. The materials are 356-T6 aluminum castings and a pultruded fiberglass rod, along with four Dacromet-coated setscrews to allow adjustability. The arms are manufactured with a "set" or cant of from 2 to 4 degrees (depending on the specific BannerFlex model) such that when there is no banner present, the top arm angles up and the bottom arm angles down.



When the banner is installed, the canted fiberglass arms conform to the rectangular shape of the banner by bending down slightly at the top of the banner and slightly up at the bottom. The final appearance is a tight, trim banner installation. This canting puts the outside edge of the banner in tension and allows the wind load to be immediately transferred to the fiberglass arms which, depending on the wind velocity will flex back and toward the center of the banner, thereby spilling wind while also absorbing some of the shock stress that gusting wind produces. This, in turn, puts less stress on the banner fabric promoting longer banner life and putting less vibration stress on the luminaire.

The new BannerFlex Airow® banner bracket is installed essentially the same way and the banner reacts essentially the same by taking on a tight, trim and rectangular shape. But, due to the eccentrically cut shape of the fiberglass arm it will spill considerable more wind force than the original BannerFlex brackets or any bracket manufactured by others that attempt to mimic the original BannerFlex bracket design. This bracket also has a UV powder coating for longer life. Banner size and quantity (one banner or two banners per pole?) are certainly significant factors. For banners of smaller than about 28" wide by 48" long the wind force is considerable less than the typically "full-size" 30" x 94" or 30" by 96" banner. Smaller banners do not proportionately spill as much wind due to significantly decreased wind loads on hardware that is designed for heavier loads. If a banner presentation is two side-by-side banners, in lieu of only one banner on a pole, the loads are doubled.

Matching-up your BannerFlex bracket choice with the diameter of your light pole

Our three BannerFlex Main Casting types will accommodate a variety of light pole diameters. Here is a rule of thumb for each of those models when using tool-applied Band-It Banding or when using Screw Gear Banding (see note below if using bolts):

- BannerFlex D3 Round Rod and D3 Airow Rod: 5" diameter to 12" diameter
- BannerFlex Metro round Rod and Metro Airow Rod: 3" diameter to 6" diameter
- BannerFlex Jr. Round Rod: 3.5" diameter to 9" diameter

Note: If using through-bolts or lag bolts for installing any of the above banner bracket options, the diameter of the pole is not as significant a factor, although for the best fit the above diameters ranges are an excellent guide. For wall mounting BannerFlex D3 brackets see page 16 of the Hardware Guidebook.

Banding and Bolting Recommendations for KBW BannerFlex® Banner Brackets

On the next page is our **Hardware Banding Guideline Chart**. Please use this to determine what is best for your installation. Our hardware is designed for ease of installation by either banding to utility poles or bolting them to poles or flat surfaces. The term “banding” refers to stainless steel strapping that is either the typical screw gear or worm gear type of fastening (similar to radiator clamps) applied using hand or power-driven tools to tighten the screw mechanism along the band to secure the hardware to the pole. We mention three (3) different strengths of this type of banding on our Banding Guideline Chart. We do not sell the ½” banding as an option because it is not strong enough for most installations. We are the only company to offer full-range 5/8” screw gear band, which is custom made for KBW by Ideal.

For larger banners, say 30” wide by 60” and bigger, especially when mounting two banners per pole, we recommend tool-applied ¾” wide Band-It® brand banding (or equal) that is “double-wrapped” for the strongest, most fail-safe installations. See the BannerFlex Installation Instructions included in this Guidebook for a pictorial explanation of Band-It and “double-wrapping”.

On what diameters of light poles will tool-applied Band-It Banding or Screw Gear Banding Work?

For the ¾” wide Band -It Band, the smallest diameter for single or double wrapped band is about 5”. If using our custom 5/8” wide by 40” long Screw Gear Band, the diameter range is 4” to 11”.

Wood Telephone and Utility Poles May Require Special Attention

Many of our BannerFlex banner brackets are banded or bolted to typical large, round wooden poles. There are inherent challenges with the bigger, older poles that have been weathering for many years. With these older poles, the outer surfaces are often softer and drier than newer poles and the Main Banner Bracket Castings may eventually press or seat into the wood through vibrations caused by wind on the banners. This seating may allow the installation to loosen and may eventually cause failure, if not properly maintained. Also, we’ve seen instances where brackets were installed in the spring or rainier time of year and then, when drier days come along (such as August in Michigan), the older wood may shrink, which could loosen the installation. The bigger the diameter of the wood pole the more surface area there will be to potentially dry and loosen.

If the bracket is through-bolted or lag-bolted you may simply be able to tighten the bolts when you see loosening occurring. And, if the installation is banded with screw gear banding, it should be possible to simply tighten the bands. However, if the loosened installation is banded with tool-applied banding, it will need to be totally re-banded with new banding, in which case we recommend that the band be “double-wrapped” twice through the buckle before clamping. If applied tightly and properly that should remedy the problem.

Bolting Options

We do not specify bolt types or sizes due to the vast array of materials into which these bolts may be placed. Generally speaking, 7/16” high-strength threaded bolts or lag screws (for wood poles) when fastened into solid, non-deteriorating materials either by through-bolting or with adequate anchors, should work fine. But, because we have no way of determining suitability of walls or wooden poles, for example, we recommend that an architect, structural engineer or licensed contractor be brought in to inspect and advise.

The Banding Guideline Chart - Choose the Strongest Option

For exterior applications, the installation must be engineered for the windiest weather, whether the display is for an indefinite, year-around program or for just a weekend. If you choose banners of inferior strength and brackets or banding options that are less than adequate, you are risking disappointment if and when that unscheduled, unseasonably big-time gust blows your installation apart. We’ve seen it happen the very next day after an inadequate installation.

The following is a guide of the banding recommendations based on our research and experience. This is a conservative guide, erring on the side of safety. Each of following describes a method of fastening the main bracket casting to the pole. Each top mount and bottom mount position (one or two banners per pole) would need two of the selected method to complete the installation – four bands per pole unless using a Tie-Down Mount, which would then need two at the top and one at the bottom for the Tie-Down Mount.



HARDWARE BANDING GUIDELINES



KBW BannerFlex Guidelines

GUIDE TO TABLE

yes - combination will work successfully in typical wind conditions (60mph)
 no - combination will not perform in typical, long-term conditions
 n/a - does not apply; size combination impossible
 N/R - combination will work, but is not recommended
 Max Total - the maximum total sq ft of banner fabric for 2 banners / pole

BANDING OPTIONS

1/2", 9/16" or 5/8" Screw Gear Bands (SGB)

Single wrap of 3/4" tool-applied banding (9 pole/100' box)-secured tightly
 Double wrap of 3/4" tool-applied banding (5 pole/100' box)

BOLTING OPTIONS

Brackets may be bolted in lieu of banding

To determine the Max Total Sq Ft, use the 2 wraps 3/4" value

| Hardware | Banner Size Inches Millimeters | 18" x 36" 460 x 915 | | 24" x 48" 610 x 1220 | | 30" x 60" 760 x 1525 | | 30" x 72" 760 x 1830 | | 30" x 84" 760 x 2135 | | 30" x 94" 760 x 2400 | | 36" x 94" 940 x 2400 | | * 30" x 120" 760 x 3050 (see below) | Maximum Single Banner Size | Maximum Total Sq Ft for 2 Banners Per Pole | |
|-----------------------|--------------------------------------|------------------------|-----|-------------------------|-----|-------------------------|-----|-------------------------|-----|-------------------------|-----|-------------------------|-----|-------------------------|-----|---|-------------------------------------|--|----|
| | | # Banners | 1 | 2 | 1 | 2 | 1 | 2 | 1 | 2 | 1 | 2 | 1 | 2 | | | | | |
| KBW-JR | 1/2" SGB | yes | yes | no | no | no | no | no | no | no | no | no | no | no | no | no | no | 20" x 36" | 10 |
| | 9/16" SGB | yes | yes | yes | no | no | no | no | no | no | no | no | no | no | no | no | no | 30" x 54" | 16 |
| | 5/8" SGB | yes | yes | yes | yes | yes | no | no | no | no | no | no | no | no | no | no | no | 30" x 60" | 16 |
| KBW-Metro | single wrap 3/4" | yes | yes | yes | yes | yes | yes | yes | yes | yes | yes | yes | yes | yes | yes | yes | yes | 30" x 72" | 25 |
| | double wrap 3/4" | yes | yes | yes | yes | yes | yes | yes | yes | yes | yes | yes | yes | yes | yes | yes | yes | 30" x 72" | 30 |
| | 1/2" SGB | yes | yes | no | no | no | no | no | no | no | no | no | no | no | no | no | no | 20" x 36" | 10 |
| KBW Metro w/ Airow | 9/16" SGB | yes | yes | yes | yes | yes | yes | yes | yes | yes | yes | yes | yes | yes | yes | yes | yes | 30" x 54" | 16 |
| | 5/8" SGB | yes | yes | yes | yes | yes | yes | yes | yes | yes | yes | yes | yes | yes | yes | yes | yes | 30" x 60" | 16 |
| | single wrap 3/4" | yes | yes | yes | yes | yes | yes | yes | yes | yes | yes | yes | yes | yes | yes | yes | yes | 30" x 84" | 25 |
| KBW-D3 | double wrap 3/4" | yes | yes | yes | yes | yes | yes | yes | yes | yes | yes | yes | yes | yes | yes | yes | yes | 30" x 84" | 30 |
| | 1/2" SGB | n/a | n/a | yes | no | no | no | no | no | no | no | no | no | n/a | n/a | n/a | n/a | 30" x 54" | 16 |
| | 9/16" SGB | n/a | n/a | yes | yes | yes | no | no | no | no | no | no | no | n/a | n/a | n/a | n/a | 30" x 60" | 18 |
| KBW-D3 w/ Airow | 5/8" SGB | n/a | n/a | yes | yes | yes | yes | yes | yes | yes | yes | yes | yes | yes | yes | yes | yes | 30" x 84" | 20 |
| | single wrap 3/4" | n/a | n/a | yes | yes | yes | yes | yes | yes | yes | yes | yes | yes | yes | yes | yes | yes | 30" x 94" | 35 |
| | double wrap 3/4" | n/a | n/a | yes | yes | yes | yes | yes | yes | yes | yes | yes | yes | yes | yes | yes | yes | 30" x 94" | 40 |
| KBW-D3 | 1/2" SGB | N/R | N/R | N/R | N/R | N/R | N/R | N/R | N/R | N/R | N/R | N/R | N/R | N/R | N/R | N/R | N/R | n/a | 10 |
| | 9/16" SGB | N/R | N/R | N/R | N/R | N/R | N/R | N/R | N/R | N/R | N/R | N/R | N/R | N/R | N/R | N/R | N/R | n/a | 16 |
| | 5/8" SGB | N/R | N/R | N/R | N/R | N/R | N/R | N/R | N/R | N/R | N/R | N/R | N/R | N/R | N/R | N/R | N/R | 30" x 60" | 16 |
| KBW-D3 w/ Airow | single wrap 3/4" | N/R | N/R | N/R | N/R | N/R | N/R | N/R | N/R | N/R | N/R | N/R | N/R | N/R | N/R | N/R | N/R | 30" x 72" | 25 |
| | double wrap 3/4" | N/R | N/R | N/R | N/R | N/R | N/R | N/R | N/R | N/R | N/R | N/R | N/R | N/R | N/R | N/R | N/R | 30" x 120" | 40 |
| | 1/2" SGB | n/a | n/a | N/R | N/R | N/R | N/R | N/R | N/R | N/R | N/R | N/R | N/R | N/R | N/R | N/R | N/R | 30" x 54" | 16 |
| KBW-D3 w/ Airow | 9/16" SGB | n/a | n/a | N/R | N/R | N/R | N/R | N/R | N/R | N/R | N/R | N/R | N/R | N/R | N/R | N/R | N/R | 30" x 60" | 18 |
| | 5/8" SGB | n/a | n/a | N/R | N/R | N/R | N/R | N/R | N/R | N/R | N/R | N/R | N/R | N/R | N/R | N/R | N/R | 30" x 94" | 20 |
| | single wrap 3/4" | n/a | n/a | N/R | N/R | N/R | N/R | N/R | N/R | N/R | N/R | N/R | N/R | N/R | N/R | N/R | N/R | 30" x 108" | 35 |
| KBW-D3 w/ Airow | double wrap 3/4" | n/a | n/a | N/R | N/R | N/R | N/R | N/R | N/R | N/R | N/R | N/R | N/R | N/R | N/R | N/R | N/R | 30" x 120" | 50 |

Disclaimer

Our Guidelines and our Warranties are based on over 35 years of experience and testing. However, due to conditions beyond our control such as quality of the actual installation, including proper application of banding and bolts, as well as structural integrity of utility poles and other construction, Consort only offers the information as a guide. When in doubt, bring in professionals for inspection and advice.

* note: this size is not covered by warranty

KBW BannerFlex® D3 ...for standard large format light pole banners



The patented original BannerFlex KBW D3 bracket has endured the test of time to become the benchmark of the banner hardware industry. KBW-D3 is the bracket of choice for standard utility and light pole installation. KBW-D3 bracket arms can be adjusted without moving the main casting or can be removed altogether and replaced with flag or flower pot holders. BannerFlex KBW-D3 offers the highest level of durability and performance and, best of all, there are no moving parts to wear out, providing peace of mind for years to come.

Features

- Patented
- 10-Year Warranty
- Canted for maximum performance
- Choice of Fastener Options
- Choice of Round or Premium Airow Rods
- Choice of Flower Pot or Flag Pole Arms
- Strong Corrosion Resistant Aluminum
- Bright Aluminum or Black Powder-Coated
- No Moving Parts to Wear Out

The benchmark of the banner bracket industry.

The BannerFlex D3 Banner Bracket

With a 70 mph “head-on” wind, one 30” x 94” banner (area = 19.575 sq ft before the wind blows) has an “Effective Projected Area” of 16.45 sq ft which means that about 16%* of the wind is spilled due to fiberglass arm deflection. At 90 mph the EPA is 15.7 sq ft and the wind reduction is about 19.83%* and, at 100 mph the EPA is 15.2 sq ft and the wind reduction is 22.38%*.

**Note that the effective projected area calculation does not take into account the wind spilled due to the “billowing” of the fabric, which actually decreases even further the wind load that is transferred to the poles. This reduction has not been calculated due of the complexity; however, suffice it to say that it would show all of these wind loads to be less than shown here.*

KBW BannerFlex D3 Main Casting

| FEATURES | BENEFITS |
|----------------------------------|---|
| 356T6 Heat-Treated Cast Aluminum | <ul style="list-style-type: none"> • Superior strength and durability • Corrosion resistant • Accepts powder coating |
| Bolt Holes | <ul style="list-style-type: none"> • Casting may be easily bolted to poles in lieu of banding application |
| Banding Channels | <ul style="list-style-type: none"> • Easily allows positioning of up to 3/4” wide banding to fasten casting to pole |
| Arm Slide Flanges | <ul style="list-style-type: none"> • Banner can be installed or removed without moving or removing main casting • Allows banner-length adjustment of 1” at both top and bottom of banner • Arms may be removed when no banners are installed • Flower Pot Holder or Flag Pole Adapters may be installed when banners are not in use |



KBW BannerFlex D3 Arm Casting

| FEATURES | BENEFITS |
|----------------------------------|---|
| 356T6 Heat-Treated Cast Aluminum | <ul style="list-style-type: none"> • Superior strength and durability • Corrosion resistant • Accepts powder coating |
| Bolt Holes | <ul style="list-style-type: none"> • Casting may be easily bolted to poles in lieu of banding application |
| Banding Channels | <ul style="list-style-type: none"> • Easily allows positioning of up to 3/4” wide banding to fasten casting to pole |
| Arm Slide Flanges | <ul style="list-style-type: none"> • Banner can be installed or removed without moving or removing main casting • Allows banner-length adjustment of 1” at both top and bottom of banner • Arms may be removed when no banners are installed • Flower Pot Holder or Flag Pole Adapters may be installed when banners are not in use |



KBW BannerFlex Standard 13/16” Round Fiberglass Arm

| FEATURES | BENEFITS |
|--------------------------|--|
| Pultruded Fiberglass Arm | <ul style="list-style-type: none"> • Provides flexibility while maintaining strength • Absorbs wind energy to reduce stress on banner and light pole • Inherent flexibility of the arm allows for return of banner to original taut position once wind subsides • Increases banner longevity |



KBW BannerFlex Premium 3/4” Airow Fiberglass Arm

| FEATURES | BENEFITS |
|--|---|
| Eccentrically Milled, Pultruded Fiberglass Arm with UV Coating | <ul style="list-style-type: none"> • Specially designed taper of fiberglass rod increases flexibility over standard rods by up to 50% • Dissipates more wind energy to reduce stress on banner and light pole • Inherent flexibility of the arm allows for return of arm and banner to original taut position once wind subsides • Increases banner longevity • Increases flexibility while maintaining strength • Perfect for high wind areas and when extra wind load reduction is required • Patent applied for |





*From the most trusted name in hardware,
the next generation of banner arm technology.*

The Revolutionary Airow Premium Rod.

A true break-through in banner bracket technology



- **Free Online Wind Force Calculator Program**
- **Flexible Yet Durable Pultruded Fiberglass**
- **Security - Especially in High-Wind Areas**
- **Increase Banner Longevity**
- **Superior Unique Design**
- **UV - Resistant Coating**

The Most Important Advancement in Banner Bracket Technology: The BannerFlex Airow®

For the crowning achievement in bracket advances, in 2004 KBW introduced the BannerFlex Airow® Rod, in response to demands from customers in high-wind areas. This unique, patent-applied-for bracket is eccentrically-shaped pultruded fiberglass with a UV coating. The shape allows more than twice the flexibility of the standard full-round arm by providing the necessary structural support nearest the pole and less and less support nearer the outside edge of the banner, thus significantly dissipating the ultimate force on the banner, the utility pole and less vibration onto the luminaire. The eccentrically milled and tapered fiberglass rod allows the BannerFlex Airow rod to deliver measurably higher wind-force reduction than any other bracket system available anywhere. Two years of extensive development and testing have proven Airow to be the ideal solution for secure high-wind installations. The Airow rod arm can be used in place of standard round fiberglass arms. And, KBW continues to research this technology.

The Premium Airow arm is available on the original BannerFlex D-3, for larger banners as well as on the BannerFlex Metro™ bracket created especially for ornamental, fluted and smaller diameter poles.

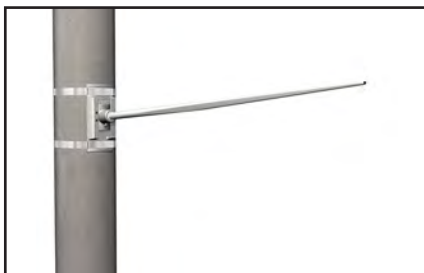
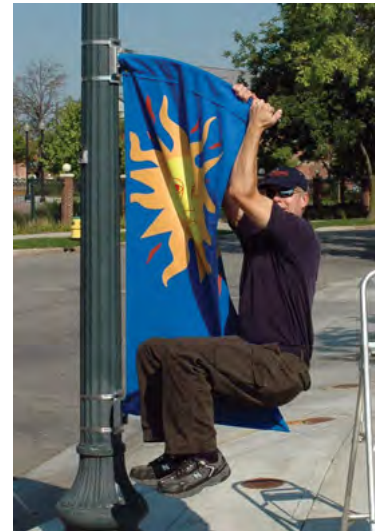

KBW BannerFlex[®]metro[®] ...for small to mid-size banners on ornamental or fluted light poles



Designed specifically for fluted, ornamental or smaller light poles, the KBW BannerFlex Metro is the perfect solution for small to mid-size banners in downtown settings. Metropolitan areas often present aesthetic and engineering challenges which the streamlined KBW Metro banner bracket solves. Enjoy all the benefits of the KBW-D3, including strength, adjustability and banner longevity, while taking advantage of the Metro's attractive appearance.

Features

- 10-Year Warranty
- Smaller Yet Adjustable Arms
- Canted for maximum performance
- Sleek and Attractive Appearance
- Installers Choice
- Worry Free
- Choice of Round or Premium Airow Rod
- Bright Aluminum or Black Powder-Coated
- No Moving Parts To Wear Out

The features of KBW-D3 in a smaller size.

The BannerFlex Metro Bracket

In 2005, KBW Consort introduced the Metro[®] bracket which was the first, and currently only, to be designed specifically to comfortably fit the majority of ornamental fluted and antique light poles. This streamlined, smaller bracket also incorporates the adjustability of the larger KBW brackets but uniquely features "inboard banding ports" for a compact, sleek look popular with architects and landscape architects.

This bracket was specifically designed with metropolitan areas in mind and is perfect for historical, informational or decorative banners in all downtown settings. The BannerFlex Metro bracket is comprised of two major components: the main bracket casting and the fiberglass arm with arm casting. It is available in both the standard round and the new premium Airow[®] rods and is protected by US patent.

KBW BannerFlex Metro Main Casting

| FEATURES | BENEFITS |
|---|---|
| 356T6 Heat-Treated Cast Aluminum | <ul style="list-style-type: none"> • Superior strength and durability • Corrosion resistant • Accepts powder coating |
| Bolt Holes | <ul style="list-style-type: none"> • Casting may be easily bolted to poles in lieu of banding application |
| Banding Channels | <ul style="list-style-type: none"> • Provides channel for up to 3/4" wide bands |
| Arm Slide Flanges | <ul style="list-style-type: none"> • Banner can be installed or removed without moving or removing main casting • Allows banner-length adjustment of 1" at both top and bottom of banner • Arms may be removed when no banners are installed |
| Dacromet [®] -Coated Set Screws and Zinc-Plated Hitch Pins | <ul style="list-style-type: none"> • Superior strength and durability • Corrosion resistant • Accepts powder coating |



KBW BannerFlex D4 Arm Casting

| FEATURES | BENEFITS |
|---|---|
| 356T6 Heat-Treated Cast Aluminum | <ul style="list-style-type: none"> • Superior strength and durability • Corrosion resistant • Accepts powder coating |
| 2-Degree Cantilevered Casting <ul style="list-style-type: none"> • Top arm is canted up • Bottom arm is canted down | <ul style="list-style-type: none"> • Wind energy is transferred from banner to fiberglass arm casting • Keeps banner trim and in tension • Promotes banner longevity |
| Eyelet included in Casting | <ul style="list-style-type: none"> • Allow for cable ties to be utilized through both the banner grommet and casting to secure banner • Added security from loss or theft |



KBW BannerFlex Standard 3/4" Round Fiberglass Arm

| FEATURES | BENEFITS |
|--------------------------|--|
| Pultruded Fiberglass Arm | <ul style="list-style-type: none"> • Provides flexibility while maintaining strength • Absorbs wind energy to reduce stress on banner and light pole • Inherent flexibility of the arm allows for return of banner to original taut position once wind subsides • Increases banner longevity |



KBW BannerFlex Premium 3/4" Airow Fiberglass Arm

| FEATURES | BENEFITS |
|--|---|
| Eccentrically Milled, Pultruded Fiberglass Arm with UV Coating <ul style="list-style-type: none"> • Airow arm available for 24" to 30" banner widths only | <ul style="list-style-type: none"> • Specially designed taper of fiberglass rod increases flexibility over standard rods by up to 50% • Dissipates more wind energy to reduce stress on banner and light pole • Inherent flexibility of the arm allows for return of arm and banner to original taut position once wind subsides • Increases banner longevity • Increases flexibility while maintaining strength • Perfect for high wind areas and when extra wind load reduction is required • Patent applied for |



KBW BannerFlex® JR ...the economy option for small to mid-size banners



The one-piece KBW BannerFlex JR is ideal for banners of 24" x 48" or smaller that fit on the smaller diameter poles. Screw-gear bands allow for easy installation and adjustment, time after time. Cast from the same strong heat-treated aluminum, the BannerFlex JR delivers comparative strength and performance to the larger BannerFlex models. The sleek low-profile allows pedestrians to focus on the banner, rather than the hardware.

Features

- 10-Year Warranty
- Ideal for Smaller Banners
- Installs Quickly and Easily with Screw Gear Bands
- Bright Aluminum or Black Powder-Coated
- Strong Corrosion Resistant Aluminum

Let your banners take center stage with BannerFlex JR.

The BannerFlex JR Bracket

The KBW BannerFlex JR bracket was specifically designed for use with smaller banners while maintaining comparative strength to our line of other BannerFlex brackets. The one-piece JR is perfect for banners 24" x 48" or smaller. Screw-gear banding allows for ease of installation and adjustment. BannerFlex JR works exceptionally well on smaller diameter or decorative poles and is available with permanent or removable fiberglass arms.



KBW BannerFlex JR Main Casting

| FEATURES | BENEFITS |
|----------------------------------|--|
| 356T6 Heat-Treated Cast Aluminum | <ul style="list-style-type: none"> • Superior strength and durability • Corrosion resistant • Accepts powder coating |
| Eyelet included in Casting | <ul style="list-style-type: none"> • Allows for cable ties to be utilized through both the banner grommet and casting to secure banner • Added security from loss or theft |
| Banding Channels | <ul style="list-style-type: none"> • Easily allows positioning of up to 3/4" wide screw-gear bands to fasten casting to pole |
| Removable Arm Availability | <ul style="list-style-type: none"> • Allows quick change of banners for seasons and events • Less obtrusive when banners are not in use |



KBW BannerFlex Premium 13/16" Round Fiberglass Arm

| FEATURES | BENEFITS |
|----------------------|---|
| Pultruded Fiberglass | <ul style="list-style-type: none"> • Provides flexibility while maintaining strength |

Other Types of Banner Brackets, in General

What about “Spring-Loaded” and “Break-Away” banner brackets? We have designed and researched systems that fit into both categories. But, none of those designs performed in a reliable or long-term mode. Nor have we found brackets manufactured by others that perform adequately that also fit into these categories. In comparison, virtually all of our original BannerFlex brackets are still in service and working properly with literally no maintenance. This is not to deny that most any reasonable bracket will work for a few months or even a few years.

Of course, it goes without saying that not only must a bracket be strong; it must also be resilient and extremely durable. For example, near major coastlines, prevailing breezes and winds are rarely less than 24 hours a day. Brackets should not only be designed to spill some amount of wind, they should also be compatible with the banner fabric, that is, flex and move with the banner to keep sewn hems intact, and they should dampen vibration that might affect the luminaire.

Spring-Loaded Systems

A spring-loaded system is a “mechanical” system. For the short term this type of system will require little maintenance. But, like an automobile, mechanical systems eventually fail. Through repetitive use, such as moving with prevailing winds, normal wear will change metal parts, change tolerances, affect the level of performance and eventually demand maintenance or replacement.

Also, spring-loaded banner arms that we have prototyped and other manufacturers’ products may have a tendency to react to violent wind gust forces where the fabric is put into stresses that may twist the banner, thereby stressing the hems. With these normal forces, banners could be damaged and non-proactive maintenance procedures may result in damage to other components on the bracket or pole such as the luminaire. In short, because of the mechanical nature of a spring-loaded system, we caution their long-term use in public areas.

Break-Away Systems

From our experience, there is no possible way to have a banner arm breakaway only when “it is supposed to.” Physics just doesn’t allow it. And, when and if it does breakaway the real problems begin. Let me explain. In an installation,



where the banner is stretched between two horizontal supports, enough strength needs to be built into the system to allow daily wind loads and sudden non-cataclysmic gusting without breaking the connections. Some breakaway systems are built on the idea of fatiguing a certain connection when high loads occur. However, fatigue can and will occur over time with prevailing winds. We’ve all broken a paperclip or wire by bending back and forth.

Other breakaway systems are built on more flexible components, such as fiberglass, that are simply undersized. It’s a great concept except for two things. One is that, in layman’s terms, broken things start flying or dangling above people for an indeterminate length of time, until repaired. Secondly, they may break during normal gusting. Breakaway systems tend to break when they are and are not supposed to. If they are tethered, which they should be, the tether will only last so long before fatiguing. And, in the meantime the light pole and the banner are being subjected to damaging forces by the dangling and banging around of whatever arm component has let go. It cannot be stressed enough: breakaway systems should be avoided.

Fasteners and Accessories

For fastening advice, please refer to the Banner Bracket Guideline on page 9. This reference piece is designed to assist in selecting the proper size and method of stainless steel banding and bolting advice for your particular specifications. This guide gives you proven experience on what will work for exterior installations based on the size and number of banners to be installed on a pole.

The options include 1/2", 9/16" and 5/8" screw gear banding as well as the proven best choice of 3/4" tool-applied Band-It® type banding. KBW is the only company to have 5/8" "captured screw gear banding" custom manufactured in a custom length to our specifications by Ideal® Banding.



Band-It Tool With Banding

Band-It is the registered trademark of IDEX Corp.



Screw Gear Banding

The above tools and hardware make installation of BannerFlex brackets easy, fast and absolutely secure. All fasteners are made of stainless steel to ensure optimal performance. Both increase ease and security of bracket installation and the screw gear banding is adjustable with power drivers or hand drivers.

The Tie-Down Mount™ Bracket allows the lower portion of a banner to flutter in the breeze and is recommended for situations where there is no bottom bracket arm and/or wind loads need to be decreased. Wind loads can be halved by attaching the lower pole-side corner with a cable tie or bungee to an anchored "tie down" and letting the outside bottom edge fly freely. This method is extremely effective but may limit the life of an acrylic textile banner to 3 to 6 months versus 5 to 8 years, depending on wind conditions. Digital banners on vinyl fabric should only be mounted this way on a temporary basis, that is, for display approximately one to three months due to the fact that typical vinyl banner materials are not as flexible as acrylic textile screen-printed banners.

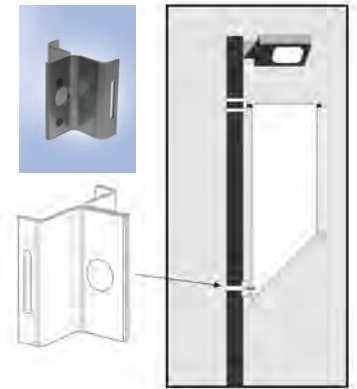

Square Pole Adaptors, also known as Adaptor Shims, are used on the back of the D3 and Metro Main Castings to fit odd-shaped fluted poles or allow more banding tension

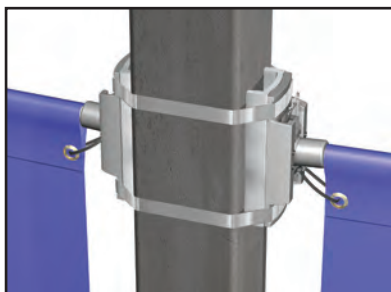

on flat-faced square poles where the faces of the poles are 5" or larger in width to place. They are manufactured to fit our hardware cross-sections and are available individually or ordered already attached to our BannerFlex hardware.



Wall Mount Plates are for mounting KBW BannerFlex® D3 Banner Brackets on exterior or interior wall applications. When utilizing this application, we recommend a special mounting between the bracket and the wall to increase the surface area of the installation.

Most exterior wall installations are brick or other masonry, wood siding or concrete. Because the banner bracket's main casting is quite small (3" x 7" - for our largest model) the wind pressure transferred from the banner to the bracket becomes quite concentrated and puts an extreme force onto a very small area during major wind events. Because the wall is not designed for this type of concentrated force, there is a tendency for the outer edges of the main casting to quickly wear into the surface.

For this reason, we recommend installing our steel plate onto the back of each main casting to provide a larger surface area in order to spread the wind load and protect the wall surface. The plates can be attached by substantial anchors or lag bolts to and/or through the wall, depending on the wall's composition. We recommend using four fastening locations per plate or through the exterior wall.

Every exterior wall-mounted installation is different and more importantly the structural integrity of the proposed mounting areas is impossible for KBW/ Consort to analyze for the customer. Due to the extra forces wind puts onto a surface, we strongly suggest a qualified professional assist to determine the appropriate size banners and mounting plates, as well the best location and method of installing banners onto walls. With that information available, KBW can then design the plates and provide the pricing information. We only warranty the products we provide in accordance with the engineer's specifications. We cannot assume any liability for the engineer's specifications, the anchoring system, mounting surface or structural integrity of the exterior wall upon which the plates and brackets are fastened.

The standard wall mount is square in shape and measures 9.50" x 9.50" and is available with a lead time of 2 – 3 business days.

Depending on the recommendation of the professional, factors such as wall integrity may influence installation. For example, bolts may need to pass entirely through the exterior wall by using an additional plate within the interior of the building. That is, the wall is then "sandwiched" by two metal plates.



STANDARD STOCK SHAPE

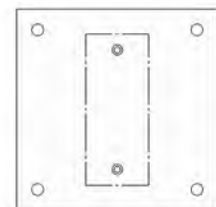

STANDARD STOCK SHAPE

SQUARE
9.50" x 9.50"

Finials for KBW BannerFlex Brackets

KBW by Consort manufactures finials, or decorative banner bracket arm ends, for all the KBW arms except the tapered "Airow®" arm. The design is a full-round, spherical 1 3/8" diameter ball which is welded to a sleeve and then glued to the end of the rod. The standard finish is black but custom colors are available with a longer lead time. The round finial is small enough to slip through 2 1/2" or larger banner hems and the banner hem will easily slide over the decorative element without the need for removal as would be necessary for larger spherical shapes.

Because the KBW finials are permanently attached to the banner arm, they will not fall off to create a hazard. Custom flat finials can also be produced on a waterjet machine and can be any shape, including letters and numbers. Please allow three (3) to six (6) weeks from the order date for custom options including shape and color.



Round Spherical Finial



Standard round finial shown w/ KBW JR hardware



KBW BannerFlex D3 Bracket Accessories

BannerFlex accessories add versatility to your banner hardware installation. The Flag Pole Adaptors and the Flower Pot Adaptors are special arms that fit within the BannerFlex D3 Main Castings to allow alternatives when banners are not displayed. The KBW D3 Main Casting must be purchased separately.

The Flag Pole Adaptor fits securely in the main casting and will accommodate a pole that is 1" in diameter by 6' in length. The Flower Pot Adaptor measures 19" exposed and cants upward slightly to bear more weight and resist sagging.

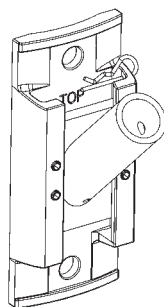

Flag Pole Adapter shown w/ KBW hardware



Flower Pot Adapter shown w/ KBW hardware



Hardware - How to Order

BannerFlex® D3, BannerFlex® Metro® and BannerFlex® JR Brackets • Hardware Illustrations

The most important part of a successful banner system is the mounting hardware. We offer three utility pole brackets assemblies: a) KBW BannerFlex D3, b) KBW BannerFlex Metro and c) KBW BannerFlex JR. Our patented BannerFlex Brackets have been subjected to extensive wind tunnel testing and have proven themselves under the severest of weather conditions. KBW brackets keep your banners stretched tightly if desired between both the top and bottom fiberglass arms. At the same time, these brackets allow banners to “flex” with gusts of wind, spilling a significant amount of wind force. This reduces stress on both the fabric and the utility poles.

Our standard BannerFlex bracket is 33” long to accommodate 30” or 31” banners. Shorter or longer lengths (up to 38”) are available for a minimum up charge. BannerFlex brackets are not recommended for banners exceeding 30” wide by 120” long or 36” wide by 96” tall in the “A” or “B” configurations shown on the following page. BannerFlex JR dimensions are given below.

| | | |
|--|--|---|
| <p>BannerFlex D3 (33” rod / 31” exposed) <i>The proven leader in reliable durable banner mounting hardware, the Bannerflex D3 is designed to hold flags and floral baskets as well as banners, this unique bracket features fiberglass arms that produce our patented “cantilever” tightening system with a minimum of parts. These brackets attach easily to any utility pole with stainless steel banding or bolt in 15 to 20 minutes per pole.</i></p> <p>KBW-D3 - One (1) casting and one (1) fiberglass adjustable arm. Two (2) needed per banner. (Also available in powder coated black)</p> <p style="text-align: center;">WITH</p> <p>C206 - Band-It® Banding (100’ roll); One roll of banding bands approximately 5 poles. (Also available in powder coated black)</p> <p>C256-B - Band-It® Buckles (box of 100) (Also available in powder coated black)</p> <p>C256-P - Band-It® Buckles (pkg of 8) (Also available in powder coated black)</p> <p>C001 - Band-It® tool - Multi purpose tool that cuts and tightens the banding and attaches the buckle.</p> <p style="text-align: center;">OR can also be bolted</p> | <p>BannerFlex Metro (21” rod / 19” exposed)** <i>Bannerflex Metro (also known as D4) is designed specifically for smaller ornamental light poles for small to mid-size banners. All the benefits of the KBW-D3 bracket, including strength and adjustability, while taking advantage of the Metro’s sleek appearance. These brackets attach easily to any ornamental or fluted light pole with the following 3 different mounting options: screw gear banding, stainless steel banding or bolts. Both types of banding materials are also available in powder coat black option.</i></p> <p>KBW-D4/19 - One (1) casting and one (1) fiberglass adjustable arm. Two (2) needed per banner. (Also available in powder coated black)</p> <p style="text-align: center;">WITH</p> <p>5/8” Screw Gear Bands - Two (2) screw gear bands needed per bracket, one band required at top and bottom of bracket. (Also avail. in powder coated black)</p> <p style="text-align: center;">OR</p> <p>C206 - Band-It® Banding (100’ roll); One roll of banding bands approximately 5 poles (Also available in powder coated black)</p> <p>C256-B - Band-It® Buckles (box of 100) (Also available in powder coated black)</p> <p>C256-P - Band-It® Buckles (pkg of 8) (Also available in powder coated black)</p> <p>C001 - Band-It® tool - Multi purpose tool that cuts and tightens the banding and attaches the buckle.</p> <p style="text-align: center;">OR can also be bolted</p> | <p>BannerFlex JR (22” rod / 31” exposed)** <i>Bannerflex JR is one-piece and designed specifically for smaller light pole banners measuring 20” x 48” or less. Installed with “screw gear” banding and available in black powder coat, this bracket is not adjustable and does not use the “cant” system like original BannerFlex hardware.</i></p> <p>KBW-JR - One (1) casting with fiberglass arm attached. Two (2) needed per banner. Removable arms available. (Also available in powder coated black)</p> <p style="text-align: center;">WITH</p> <p>5/8” Screw Gear Bands - Two (2) screw gear bands needed per bracket, one band required at top and bottom of bracket. (Also available in powder coated black)</p> |
|--|--|---|

D3 Main casting is 3”w x 7 ¼” l; D3 fiberglass arm 13/16” ; Metro /D4 casting is 2 9/16”w x 4 3/8”l; Metro/D4 fiberglass arm ¾” JR casting is 2 ¼”w x 4 ¾”l; JR fiberglass arm 13/16” ; All Airow fiberglass arms are ¾” ; Average light pole is 8” to 9” in diameter.

Packaging information: Each box measures 42”l x 8”h x 10”w

25 KBW D3 per box = 70 pounds

30 KBW Metro per box = 47 pounds

40 KBW JR per box = 60 pounds

Visual Configuration Examples

KBW - A Configuration

KBW D3

Two (2) banners per pole: hardware consists of the following:
4 main castings, 4 arm castings with 31" fiberglass arms, 4 hitch pins,
16 dacromet set screws, 3/4" Band-It Banding and buckles

KBW AIR 31"

Two (2) banners per pole: hardware consists of the following:
4 main castings, 4 arm castings with 31" fiberglass arms, 4 hitch pins,
16 dacromet set screws, 3/4" Band-It Banding and buckles

KBW D4 (Metro) with 19" rod

Two (2) banners per pole: hardware consists of the following:
4 main castings, 4 arm castings with 19" fiberglass arms, 4 hitch pins,
16 dacromet set screws, 3/4" Band-It Banding and buckles

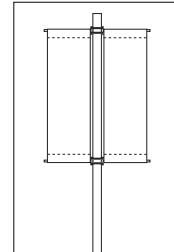

KBW - B Configuration

KBW D3

One (1) banner per pole: hardware consists of the following:
2 main castings, 2 arm castings with 31" fiberglass arms, 2 hitch pins,
8 dacromet set screws, 3/4" Band-It Banding and buckles

KBW AIR 31"

One (1) banner per pole: hardware consists of the following:
2 main castings, 2 arm castings with 31" Airow arms, 2 hitch pins,
8 dacromet set screws, 3/4" Band-It Banding and buckles

KBW D4 (Metro) with 19" rod

One (1) banner per pole: hardware consists of the following:
2 main castings, 2 arm castings with 19" Airow arms, 2 hitch pins,
8 dacromet set screws, 5/8" Screw Gear Bands

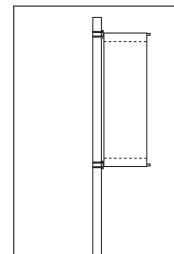

We are always happy to custom make fiberglass arms shorter or longer than 31" exposed (from casting collar to tip) for minimal up charge.

With these examples, banding is estimated to be 20' per pole. Individual needs may vary depending on diameter of light or utility pole.

Depending on banner size, Airow and Metro® brackets can be mounted with screw gear bands instead of the banding material.

KBW BannerFlex Instructions

PLEASE READ THIS FIRST!

All hardware is shipped with appropriate bracket installation instructions in box. Do not render your KBW BannerFlex® warranty null and void. This portion of the Banner Hardware Guidebook is intended as informational only.

BE SURE TO READ THE FULL HARDWARE INSTALLATION INSTRUCTIONS INCLUDED WITH YOUR SHIPMENT THOROUGHLY PRIOR TO INSTALLATION!

It is the customer's responsibility to determine to his or her own satisfaction the light poles (or other poles) are able to withstand the increase load by the installation of one or more banners of a particular size on that pole using top and/or bottom arm BannerFlex Brackets. We recommend that you contact the pole manufacturer or a structural engineer to assist in the making of this determination. See following pages for each specific banner bracket and the list of tools required to install each.

*For older poles, we suggest visual inspections to determine the current structural integrity of the base connection as well as other portions of the pole, including the luminary components. If you have any questions concerning bracket installation, please contact your **KBW Sales Representative or the "Hardware Hotline" at 800.525.6424.***

General Installation Guidelines

- Always verify that high profile traffic, such as buses and trucks, will not come in contact with the installed brackets. Make sure the bottom bracket is high enough.
- The KBW BannerFlex® D3 main casting is designed to be attached to poles with bolts, screw-gear banding or tool-applied Band-It® solid banding.
- The KBW BannerFlex® Metro is designed to be attached to poles with bolts, screw-gear banding or tool-applied Band-It® solid banding.
- Square utility poles that are 5" or wider in each flat dimensions will need a Square Pole Adaptor Plate as listed on p25.
- "Fluted" poles sometime do not allow an installation to face a particular direction due to the location of the flutes. We have found that slight angles away from perpendicular, for example, are not objectionable.
- These instructions specifically explain banding the bracket to the poles. If bolts are used, continue to refer to the instructions for placement and proper use of the "canting feature".

Maintenance Guidelines

- We recommend new installations be visually inspected 30 days after initial installation to insure brackets are tight and trim, and every 60 days thereafter. Also inspections should take place after unusually heavy windstorms, as abnormal gusts and flying debris may affect the quality of an installation.
- Banners which "whip" or "flutter" in the wind are not installed properly. This may cause undue wear and tear on the banner and eventually release from the bracket, which can heavily damage the banner. Avoid this problem with inspections as suggested above. Repair loosened banners immediately.
- Banners with puckers or stress lines along the fabric are too tight. Loosen and adjust the lower arm until banner is taut but smooth. (See "Troubleshooting" on page 26 for more information).
- Do not allow banners to come into contact with wires, signs, flag holders, etc. as these will wear on banners.

KBW BannerFlex D3 Installation Instructions

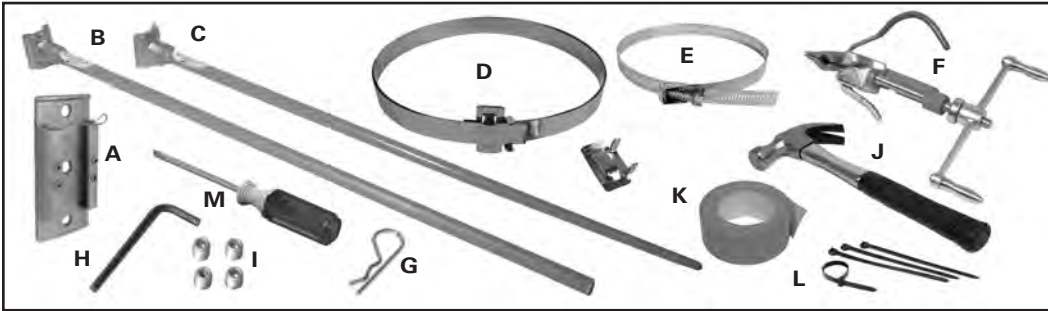

- A. Main Pole Casting
- B. Standard Arm/Arm Castings
- C. Premium Airow Rod
- D. Band-It Banding & Buckle
- E. Screw Gear Banding
- F. Band-It Tool
- G. Hitch Pin
- H. Hex/Allen Wrench
- I. 4 Dacromet® Set Screws
- J. Hammer
- K. Duct Tape
- L. Nylon Cable Ties
- M. Screwdriver/Powerdriver

Please Read Completely Before Beginning Installation!

Start with the top banner bracket by mounting upper Main Casting(s) (A) first and complete all "top" procedures, including mounting the banner(s) and Nylon Cable Ties (L), before mounting lower casting(s). The upper castings must be mounted at a height that prevents any portion of the completed banner installation from being hit by vehicular traffic or pedestrians (see diagram right). You may use these instructions for both single and double banner per pole installations. First, inspect every pole to see if anything on the pole would wear against the banner fabric. Items to look for include signs and banding, flag pole holders, power or telephone lines or any other obstructions on the pole that might come into contact with the banner. Any object contacting a banner will eventually damage the banner, the object or both.

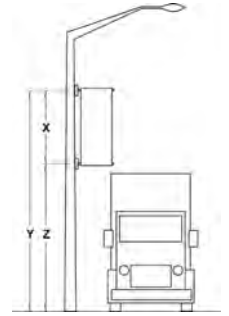

Band-It Banding Instructions



1 Slide buckle onto Band-It (D) by feeding buckle onto band "teeth first" (see Band-It instructions included with tool).

2 Bend end of band under buckle about 2". You can use a hammer to crease band end down.

3 Using Duct Tape (K), temporarily hold casting(s) in place against utility pole at desired height. The word "TOP" on the Main Pole Casting (A) must point up at ALL times for both Main Castings at both upper and lower locations.

4 Double wrap Band-It completely around pole at both the top part of the pole casting and the bottom part of the pole casting.

5 Be sure you understand double wrapping before proceeding.

6 Tighten the banding according to the instructions provided with the Band-It tool (F). Cut off excess banding with Band-It tool (F).

7 Pound Band-It down over buckle and pound buckle tabs over banding to secure each double wrapped band in place. Remove the duct tape.

8 Remove Hitch Pin (G) from Main Casting and install upper Arm Casting (B or C) so the "BANNER" points toward where the banner will be located. Position the Arm Castings in the center of the Main Casting - this will allow some minor length adjustment either up or down, should the banners require adjustment. Re-install Hitch Pin.

Note: BannerFlex Arms are "canted" to put the banner in tension. This means that without a banner installed the upper arms will angle up slightly and the bottom arms will angle down slightly. When the banner is properly installed, the installation will be taught and trim. The fiberglass will bend down at the top and up at the bottom to make the banner appear square and stretched. This allows the wind to be immediately transferred to the fiberglass for deflection.

KBW BannerFlex D3 Installation Instructions (Continued)

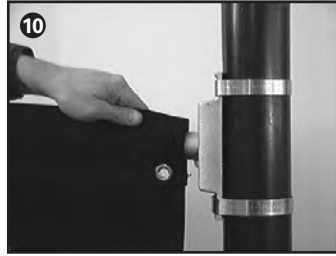

9 Tighten the Dacromet® Set Screws (I) with the appropriate Allen Wrench (H). Power tools are recommended here as well, for a speedy installation.

10 Slide top banner hem over fiberglass arm, grommet side first. Grommet side is closest to the pole. Allow banner to unfurl. Place banner hem up to (or over) the Arm Casting. Either look is acceptable but we recommend each banner be installed the same way for best appearance.

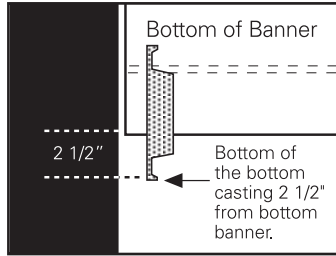

11 Slide second banner on opposite arm if mounting two banners per pole. Feed the Nylon cable Tie (L) [or 18 gauge or larger galvanized wire] through the banner grommet and through the "eye" hole in the Arm Casting. This attachment is required to prevent the banner from sliding off.

Top portion of installation is now finished. Now you are ready to install the bottom Main Castings.

12 Pull banner down to mark pole for location of bottom casting/arm assembly. Mount bottom casting so that lowest edge of casting is approximately 2 1/2" lower than the bottom edge of the banner.



Repeat steps 1 through 7 to mount lower Main Castings in place.

13 14 Before putting Arm Castings into Main Castings, slide banner over the fiberglass arm. Important: see illustration on this page to understand how to slide arm casting into pole casting. When inserted correctly, bottom arms display a downward "cant" until banner is tightened between each arm. It will "bind up." See note in step #15 and illustrations at left for proper method. Be sure the banner arrows point towards the banner.

These next steps are very important! Please read carefully!

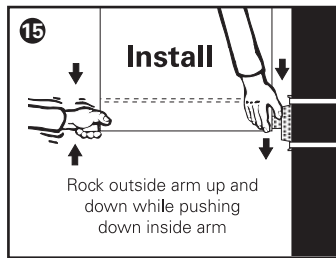

DO NOT USE EXCESSIVE FORCE OR TOOLS! IT IS NOT NECESSARY - Refer to illustration 15 to understand how to slide the Arm Casting into the Main Casting. Use a rocking action to position the Arm into place. Rock the Arm Casting until it is as far down into the Main Casting as possible and banner is tight and trim. If the banner(s) appear "pigeon-toed" or "fanned out," please see **TROUBLESHOOTING**.

15 ROCKING THE ARM INTO PLACE - VERY IMPORTANT! Each bottom arm can be easily "rocked" into position - see illustrations. Rock the arm assembly in the casting slot by pushing down on the outer end of the fiberglass arm and at the same time pressing the top of the Arm Casting downward with a thumb. Keep rocking the arm until it is seated as far down as it will go and the banner is taut. The arm should remain in position to tighten the Dacromet Set Screws (I). Note: excessive hammering may damage the Casting and voids the KBW warranty.

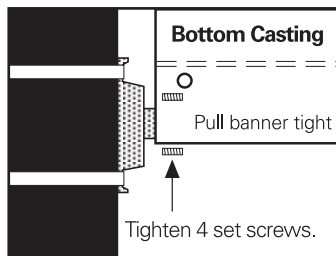
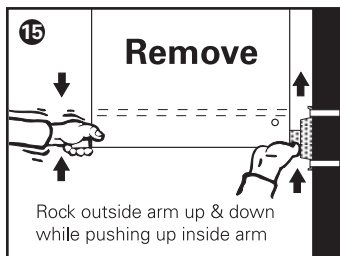

Secure the bottom of the banner to Main Casting with a Nylon Cable Tie (L) [or 18 gauge or larger galvanized wire] through the banner grommet and through the "eye" hole in the Arm Casting. This attachment is required to prevent the banner from sliding off.

CONGRATULATIONS! The banner installation is complete! If the banners appear "pigeon-toed" or "fanned out," please see **TROUBLESHOOTING** on page 26.

KBW BannerFlex Metro Installation Instructions

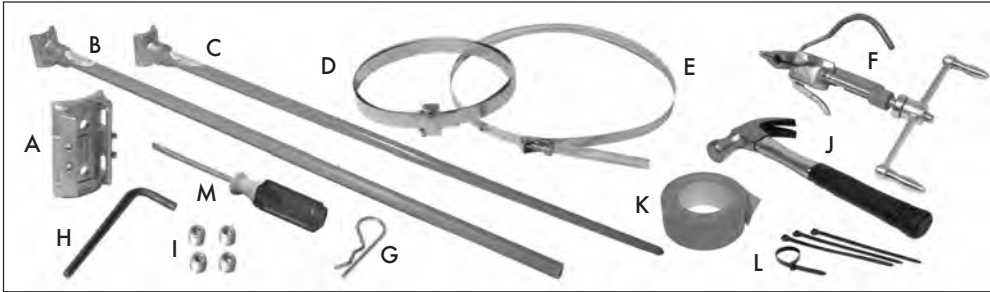

- A. Main Pole Casting
- B. Standard Arm/Arm Castings
- C. Premium Airrow Rod
- D. Band-It Banding/Buckle
- E. Screw Gear Banding
- F. Band-It Tool
- G. Hitch Pin
- H. Hex/Allen Wrench
- I. 4 Dacromet® Set Screws
- J. Hammer
- K. Duct Tape
- L. Nylon Cable Ties
- M. Screwdriver/Powerdriver

Please Read Completely Before Beginning Installation!

Start with the top banner bracket by mounting upper Main Casting(s) (A) first and complete all “top” procedures, including mounting the banner(s) and Nylon Cable Ties (L), before mounting lower casting(s). The upper castings must be mounted at a height that prevents any portion of the completed banner installation from being hit by vehicular traffic or pedestrians (see diagram right). You may use these instructions for both single and double banner per pole installations. First, inspect every pole to see if anything on the pole would wear against the banner fabric. Items to look for include signs and banding, flag pole holders, power or telephone lines or any other abutments on the pole that might come into contact with the banner. Any object contacting a banner will eventually damage the banner, or the object, or both.

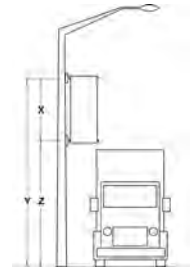

SCREW GEAR BANDING INSTRUCTIONS

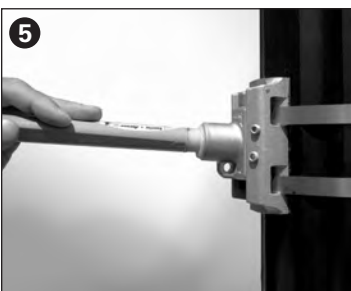
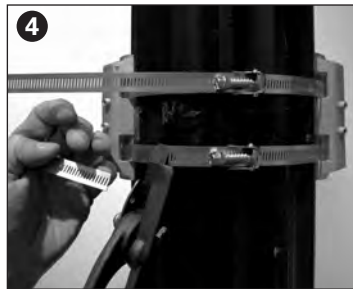
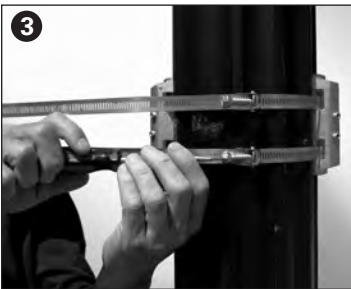
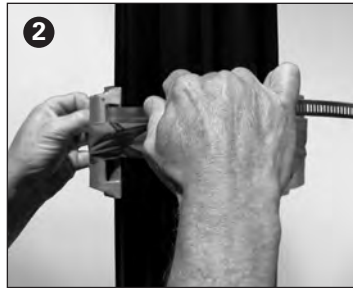

1 Using Duct Tape (K), temporarily hold casting(s) in place against utility pole at desired height. The word “TOP” on the Main Pole Casting (A) must be pointing up at ALL times for both Main Castings at both upper and lower locations.

2 Thread Screw-Gear Band (E) through the casting’s banding ports and wrap around the pole. For double banner installations put the same band through both casting’s band ports. Note: Put a slight arc or bend in the band to assist with threading it into the rounded profile of the casting.

3 Before screwing banding too tightly, re-check Main Casting locations to be sure they have stayed in position. Secure banding as tightly as possible without over-tightening and damaging threads. Initially, this may take some trial and error to get the “feel” of a tight and secure installation. We recommend power tools for this tightening procedure, to save time.

4 Clip excess banding for a trim, finished look and to avoid damaging the banner. Consider tucking the “tails” into the banding ports, being careful not impede the Arm Casting from sliding freely.

5 Remove Hitch Pin (G) from Main Casting and install upper Arm Casting (B or C) so the “BANNER” points toward where the banner will be located. Position the Arm Castings in the center of the Main Casting – this will allow some minor length adjustment either up or down, should the banners require adjustment. Re-install Hitch Pin.

Note: BannerFlex Arms are “canted” to put the banner in tension. This means that without a banner installed the upper arms will angle up slightly and the bottom arms will angle down slightly. When the banner is properly installed, the installation will be taught and trim. The fiberglass will bend down at the top and up at the bottom to make the banner appear square and stretched. This allows the wind to be immediately transferred to the fiberglass for deflection.

6 Tighten the Dacromet® Set Screws (I) with the appropriate Allen Wrench (H). Power tools are recommended here as well, for a speedy installation.

KBW BannerFlex Metro Installation Instructions (Continued)

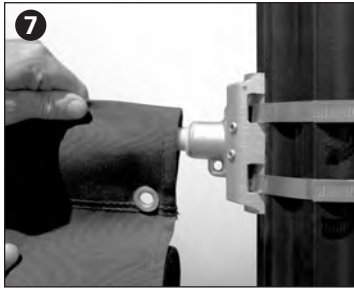

7 Slide top banner hem over fiberglass arm, grommet side first. Grommet side is closest to the pole. Allow banner to unfurl. Place banner hem up to (or over) the Arm Casting. Either look is acceptable but we recommend each banner be installed the same way for best appearance.

8 Feed the Nylon Cable Tie (L) [or 18 gauge or larger galvanized wire] through the banner grommet and through the “eye” hole in the Arm Casting. This attachment is required to prevent the banner from sliding off.

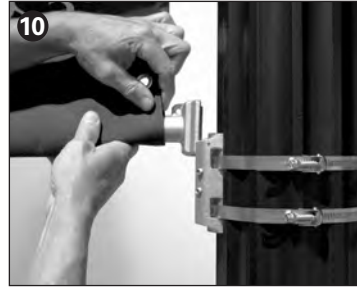

Top portion of installation is now finished. Now you are ready to install the bottom Main Castings.

9 Use the banner as a guide to determine the mounting position of the bottom Main Casting. Pull the banner down taut and clearly mark a guide line on the pole at the lowest edge of the banner. Position Main Casting so the bottom edge is 1” lower than the guideline.

Repeat steps 1 through 7 to mount lower Main Castings in place.

10 11 Before putting Arm Castings into Main Castings, slide the banner over the fiberglass arm.



12 13a&b These next steps are very important! Please read carefully!

DO NOT USE EXCESSIVE FORCE OR TOOLS! IT IS NOT NECESSARY

- Refer to illustration 13 to understand how to slide the Arm Casting into the Main Casting. Use a rocking action to position the Arm into place. Rock the Arm Casting until it is as far down into the Main Casting as possible and banner is taut and trim. If the banner(s) appear “pigeon-toed” or “fanned out,” please see TROUBLESHOOTING.

ROCKING THE ARM INTO PLACE – VERY IMPORTANT!

Each bottom arm can be easily “rocked” into position –see illustrations. Rock the arm assembly in the casting slot by pushing down on the outer end of the fiberglass arm and at the same time pressing down the top of the Arm Casting downward with a thumb. Keep rocking the arm until it is seated as far down as it will go and the banner is taut. The arm should remain in position to tighten the Dacromet Set Screws (I). Note: excessive hammering may damage the Casting and voids the KBW warranty.

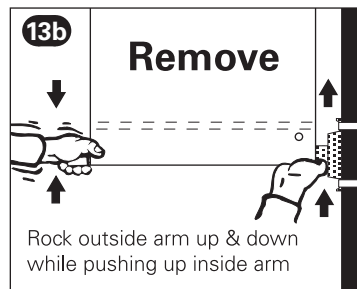
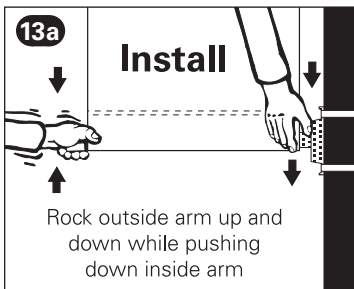

14 Secure the bottom of the banner to Main Casting with a Nylon Cable Tie (L) [or 18 gauge or larger galvanized wire] through the banner grommet and through the “eye” hole in the Arm Casting. This attachment is required to prevent the banner from sliding off.

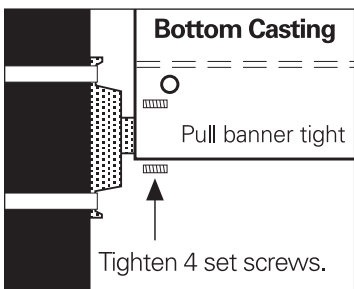

15 CONGRATULATIONS! The banner installation is complete! If the banners appear “pigeon-toed” or “fanned out,” please see TROUBLESHOOTING on page 26.

KBW BannerFlex Jr. Installation Instructions

- 1 Mark the utility pole at desired height.
- 2 Install top arm first. Hold the casting up to the pole so that the word "BANNER" with arrows points **DOWN**. Wrap banding around pole at both the top part of the casting and the bottom part of the casting. Position the banding so that it goes over the flat areas on the casting. **See Figure 1.**
- 3 Tighten the screw gear banding with a screwdriver. If using Band-It banding, tighten according to the instructions provided with the Band-It tool. The banding should be tightened down onto the flat areas on the casting and cover the words "BANNER" and "KBW".
- 4 Slide banner (top hem) on arm. Slide banner on grommeted side first. Completely cover the metal sleeve at base of arm so banner is very close to the pole casting.
- 5 Now you are ready to mount lower arm. Pull banner down to mark pole for location of bottom casting/arm assembly. Be sure that the word "BANNER" with arrows points **UP**. Mount bottom casting low enough to ensure that the banner will be held tight.

Repeat steps 1-5 to mount lower casting/arm to pole.

- 6 Insert the nylon cable tie or #18 gauge wire through grommet(s) in banner(s). Either put through the loop in the casting(s) or wrap around the utility pole and secure. **See Figure 2.** This must be done to secure the banners to the pole.

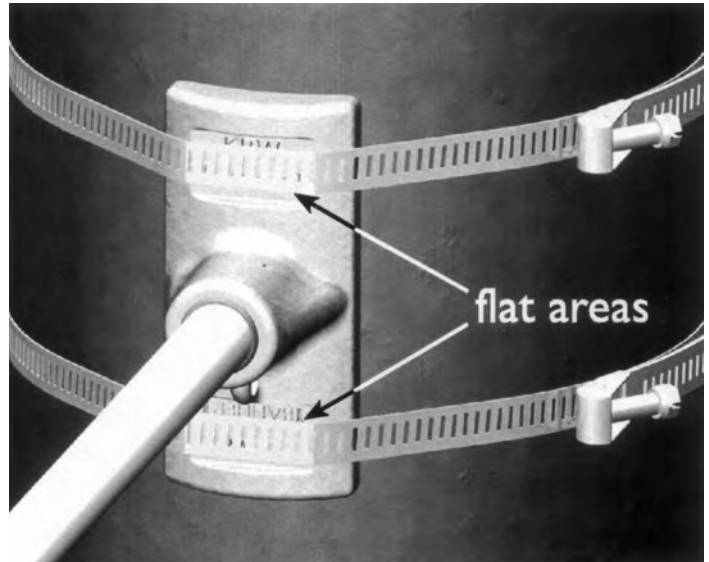

Figure 1

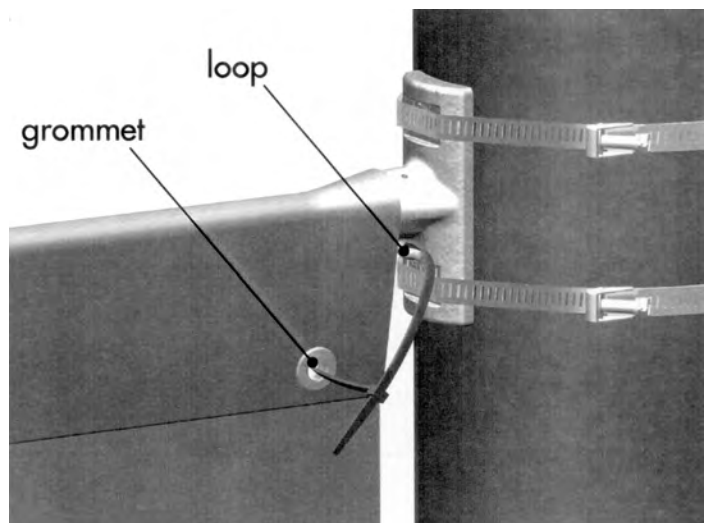

Figure 2

Square Pole Information

For utility poles that have a square "cross section" where the faces of the pole measure 5" or wider, a square pole adapter is recommended. This allows the banding to apply the proper pressure onto the casting.

KBW will attach adapter and casting together when requested with bracket ordered. When ordered separately, the adapter will be ready to attach to the casting with included bolts. It will be necessary to drill two holes in the casting to properly attach the casting to the adapter.

The above information applies to installations which are "banded" to the pole, not bolted. Square pole adapters are not needed on square utility poles that have bolts. Please call if assistance is needed.

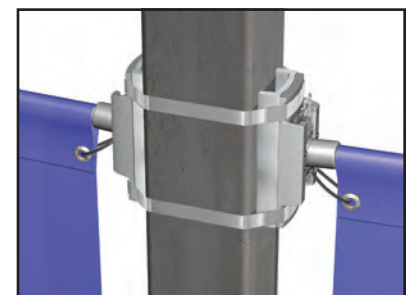

TROUBLE SHOOTING for Banner Installation and Maintenance

Are banners “pigeon-toed or not square or perpendicular to pole? This indicates that either the upper or lower Arm Casting is not “seated” properly in the Main Casting. The pigeon-toed look can be fixed by spreading the upper and lower arms apart more. Either lower the bottom Arm Casting further into the Main Casting, or raise the upper Arm Casting further into the top Main Casting. If there is not enough space in the Main Casting for this, either raise the upper Main Casting or lower the bottom Main Casting on the pole.

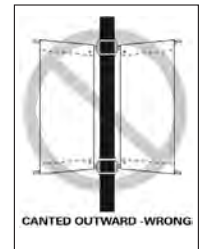
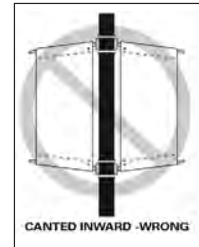

Illustration shows correct arm angle of finished installation

Is either the top of the banner slanted down significantly or the bottom of the banner slanted up significantly or both? This indicates one or both of the arms are installed upside down. Make sure the arrows beside the word, “BANNER” on the Arm Casting are pointed toward the actual banner.

Is the banner loose or flapping around? This usually indicates the Arm Castings are not seated properly to keep the banner trim and tight. Review number 10-14 in the Installation Instructions.

Are the banners puckered or do they have stress lines in them? This may occur with certain fabrics and certain size banners. It results from the banner being stretched too tightly or the arms not being parallel (see Troubleshooting 1 and 2 above). We recommend sliding the banner hem further over the Arm Casting’s aluminum stub to relieve some of the puckering.

Are you seeing tearing or ripping of the banner fabric? With the high quality KBW banner fabrics, warranted for 2 years, you should never see this unless something is rubbing against the banner or if the installation has been allowed to flap around without proper maintenance. Other non-KBW banner fabrics may simply be too weak for exterior use. First check to see if the installation is trim and tight. Next see if anything on the utility pole has been allowed to wear against the banner fabric. Foreign objects will always damage the banner eventually.

Almost every light pole is tapered. When the KBW bracket system has been correctly installed it will not loosen or crawl up a tapered pole.

Are the Main Castings loosening on the pole and/or “crawling” up a tapered pole? Anytime a Main Casting is loose it is typically a result of three causes. First and usually, it may be the fastening, such as Band-It® Banding or Screw Gear Banding, is not installed properly and is not tight enough. With larger banner installations where “double wrapping of ¾” Band-It Banding is specified, double wrapping means the band needs to go around the pole twice before the Band-It Buckle is clamped. For Screw Gear applications, be sure the correct size and strength of band has been applied and that it has been tightened properly.

The second most common reason an installation may loosen is if it has been hit by a vehicle which has made contact with the bottom arm.

Third, an unusual or catastrophic windy condition may cause loosening or damage by flying objects hitting the installation.

Warranty for BannerFlex® Hardware

KBW BannerFlex® banner brackets are warranted for twelve (12) years from the date of Consort Display Group invoice against defects in material and workmanship when installed according to KBW installation instructions and when used to support banners in the standard KBW size of 30" wide x 94" long or smaller*.

REMEMBER: Refer to KBW Hardware Banding Guideline Chart (page 9) for proper methods of attachment. Also, bracket installation must be inspected 30 days after the installation and every 60 days thereafter, making any necessary adjustments immediately.

This warranty does not apply where equipment is used, or installation performed in any manner contrary to KBW's specifications and instructions, nor where equipment is altered or modified. Excessive force (hammering, etc.) is not necessary and will damage the castings and void the warranty. Nor does the warranty cover installation or removal costs incurred by customer. BannerFlex brackets are warranted to withstand wind gusts up to 80 MPH when used with banners measuring 30" wide x 94" long or smaller.

KBW BannerFlex® JR Brackets are warranted for twelve (12) years from the date of Consort Display Group invoice against defects in material and workmanship when installed according to KBW installation instructions and when used to support banners in the standard KBW size of 20" wide x 48" long or smaller.

***BANNER & BRACKET SIZE NOTE:** BannerFlex Airow 37" exposed carries a warranty for 36"x94" banners or smaller when installed according to KBW installation instructions. BannerFlex Airow 31" exposed arm brackets carry a warranty for 30"x120" banners or smaller when installed according to KBW installation instructions. Custom products that are manufactured larger than our standard sizes by be subject to the above or to different warranties depending upon specifications. Please contact your sales representative for possible limited warranty

Screw-Gear Banding products and Tool-Applied Banding and Banding Tools are not manufactured by Consort. These are warranted by each manufacturer for one-year against defects in material and workmanship when applied and installed according to each manufacturers' instructions.

To file a Warranty Claim the following information will need to be submitted:

- Invoice number of original bracket order
- Date of bracket failure
- Describe the weather conditions at time of failure
- Location (ZIP code) of bracket failure
- What size banners are installed on the banner brackets, W" x H"?
- Is banner installation vulnerable to truck traffic?
- At least (2) close-up photos, at different angles, of failed banner bracket
- At least (1) photo taken from further back showing complete banner installation

And Finally: The All-Important, Official Consort KBW Disclaimer

Consort provides this data for customer convenience. Consort does not assume any liability associated with use of this data by anyone. It is the customer's responsibility to determine to his/her own satisfaction that the structures (light poles, buildings, etc.) are able to withstand the increased wind load generated by the installation of one or more banners of a particular size on that structure using Consort banner brackets. Consort always recommends that the pole manufacturer or a structural engineer be consulted in making that determination. As mentioned previously, be sure to read the full hardware installation instructions included with your shipment thoroughly **PRIOR** to installation. Contact your Consort KBW sales representative for any additional information or if anything within this document is unclear.

Our office is located in Kalamazoo, MI and someone is available to assist you Monday - Friday 8a.m. to 5p.m. E.S.T. - (800) 525-6424 or (269) 388-4532. Also visit us online at www.kalamazoobanner.com or www.consort.com.



CONSORT
DISPLAY GROUP

2129 Portage Street • Kalamazoo, MI 49001
 TF: 800.525.6424 • PH: 269.388.4532 • FAX: 888.880.6341
www.consort.com • info@consort.com